

FLIP
DOSSIER

DESIGN
DYNAMOBEL

dynamobel

FLIP

FLIP

CREA TU ESPACIO

Sabemos que en el entorno de oficina hay espacios colectivos y dedicados a la formación que demandan soluciones con funciones de movilidad especiales. Atendiendo a este tipo de requerimientos, Dynamobel ha diseñado la mesa Flip, una mesa móvil, abatible y aparcable que ha sido desarrollada con una gama dimensional y de acabados orientada a cubrir este tipo de necesidades.

Mediante un sistema de anclaje orientable de fácil manejo, las mesas pueden ser unidas entre sí obteniendo diferentes configuraciones, una funcionalidad añadida que sirve para dar orden a las diferentes composiciones creadas.

Flip también incorpora soluciones para la conducción de la electrificación, entre las que se encuentran una tapa abatible, una bandeja y una columna articulada para la subida de cableado desde el suelo hasta la encimera de la mesa.

CREATE YOUR SPACE

Office environments often include communal areas used for training which call for solutions which can be moved around easily to adapt to the specific circumstances.

And so, with just this idea in mind, Dynamobel has come up with the Flip desk, a table which can be moved, folded and nested, and comes in a range of sizes and finishes designed to meet requirements of this kind.

The easy-to-use swivelling anchor system means that the tables can be joined up together neatly to create different configurations, adding functionality to the system.

Flip also offers cable management solutions, including a flip-up cover, a cable tray and a jointed cable riser.





FLIP FLIP



◀ **Vista inferior de la mesa.**
Underside of the desk.

▼ **La movilidad de la mesa permite crear diferentes composiciones.**
The tables can be moved around to create different compositions.





DETALLES DETAILS



Mecanismo de plegado.
Flip-top mechanism.



Adosabilidad a otras mesas de forma lateral y frontal.
Attachable to other desks on the front and side.



Subida de cables articulada.
Articulated cables raise.

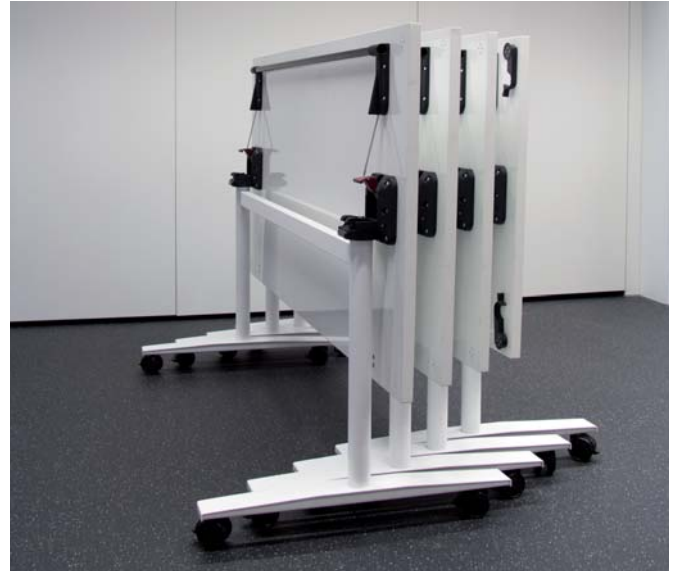

Aparcabilidad.
Nesting.



Frenado de las 4 ruedas.
Locks on the 4 castors.



Caja de enchufes integrada.
Power strip built into the desk top.



Tapa abatible con acceso al canal.
Flip-up cover providing access to the cable channel.

GAMA RANGE

MESA ABATIBLE APARCABLE NESTING FLIP-TOP DESK

SERIE 80

A 80 F 120 / 140 / 160

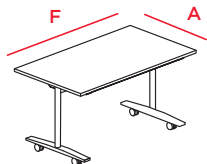

SERIE 70

A 70 F 120 / 140 / 160

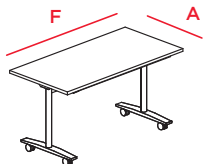

SERIE 60

A 60 F 120 / 140 / 160

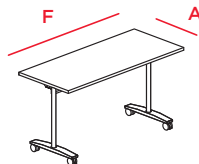

COMPLEMENTOS ACCESSORIES

FALDÓN

MODESTY PANEL

F 120 / 140 / 160 H 30

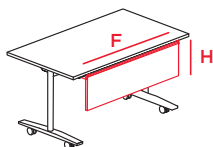

KIT ADOSABILIDAD CONNECTION KIT



SUBIDA DE CABLES ARTICULADA ARTICULATED CABLE RAISE

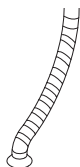

LATIGUILLO CONEXIÓN CONNECTION CABLE



CANAL ELECTRIFICACIÓN CABLE TRAY

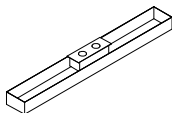

TAPA ABATIBLE FLIP-UP COVER



CARACTERÍSTICAS TÉCNICAS

TECHNICAL FEATURES

TABLERO

Disponible con acabado:

- **Aglomerado** de partículas de madera de 25 mm de espesor.
- **Laminado**. El canto de PVC de 2 mm de espesor.
- **Estratificado** de alta densidad (HPL) en la cara superior e-0.8 mm y un contratiro en la inferior. El canto de PVC de 2 mm de espesor.
- **Madera** con tratamiento de barnizado en alta resistencia. Canteado en madera de 2 mm de espesor.

ESTRUCTURA

Patas de tubo de acero.

PIES

Base de chapa plegada de 4 mm de espesor.

RUEDAS

Con freno, diámetro 65 mm.

MECANISMO ACCIONAMIENTO

Accionamiento mediante una barra de acero.

PRESTACIONES OPCIONALES

- Caja de enchufes integrada en tablero con canal de electrificación simple horizontal.
- Tapa abatible frontal con bandeja para caja de enchufes en 2 acabados.
- Subida de cables vertebrada para mesas individuales.
- Adosabilidad frontal y lateral.

DESK TOP

Available in:

- 25-mm thick **chipboard** with.
- **Laminated** finish. 2-mm thick PVC edge.
- **0.8-mm thick HPL** finish on top and HPL balancing sheet on the bottom. 2-mm thick PVC edge.
- **Wood** finish treated with high-resistance varnish, with 2-mm thick wood edging.

STRUCTURE

Legs made of steel tubing.

FEET

Folded 4-mm thick steel bases.

CASTORS

With locks. 65 mm in diameter.

OPERATION MECHANISM

Operated by steel bar.

OPTIONAL FEATURES

- Power strip built into the desk top with single horizontal cable channel.
- Flip-up cover with tray for power strip in 2 finishes.
- Jointed cable riser for individual desks.
- Attachable to other desks on the front and side.

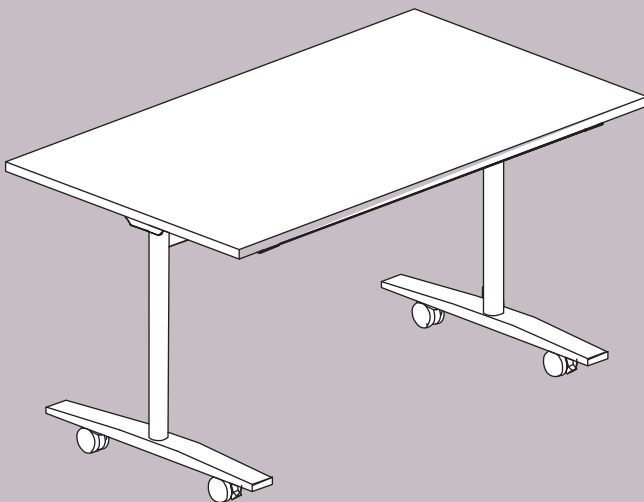

ACABADOS FINISHES

MADERA · WOOD VENEER



RB Roble blanco
White oak



RG Roble gris
Grey oak



RS Roble negro
Black oak



RC Roble crema
Cream oak

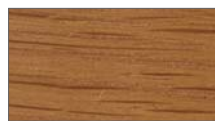

RD Roble miel
Honey oak



RP Roble marrón
Brown oak



MB Mallada blanca
White straight grain

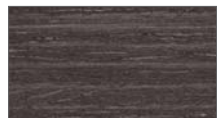

MG Mallada gris
Grey straight grain



MS Mallada negro
Black straight grain



MC Mallada crema
Cream straight grain



MD Mallada miel
Honey straight grain



MP Mallada marrón
Brown straight grain

MADERA N · N VENEER



AB Arce blanco
White maple



AN Arce natural
Natural maple



NB Nogal blanco
White walnut



NG Nogal gris
Grey walnut



NN Nogal
Walnut



NM Nogal miel
Honey walnut

HPL · HPL

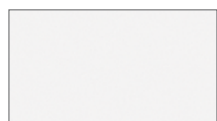

BA Blanco
White

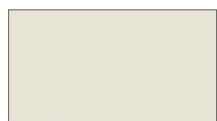

BC Blanco crema
Cream white

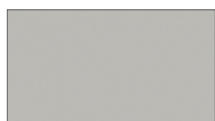

GC Gris claro
Light grey



R2 Roble Peralta
Peralta oak



R4 Roble Aurora
Aurora oak



R6 Roble Colorado
Colorado oak



RM Roble
Oak

MELAMINA · MFC LAMINATE

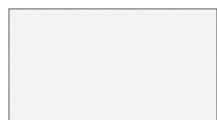

BA Blanco
White

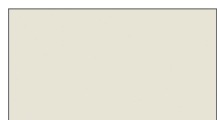

BC Blanco crema
Cream white



GC Gris claro
Light grey



R2 Roble Peralta
Peralta oak



R4 Roble Aurora
Aurora oak



R5 Roble Denver
Denver oak



R6 Roble Colorado
Colorado oak



RM Roble
Oak



GU Ugu
Ugu

ACABADOS FINISHES

COLORES PLANOS (Pintura lisa) · PLAIN COLORS (Plain epoxy)

					
AK Azul electrico Electric blue	AJ Azul marino Navy blue	AG Azul roto Storm blue	AF Azul gélido Ice blue	AE Azul grisáceo Grey blue	BA Blanco White
					
VV Verde primavera Spring green	GV Gris verdoso Greenish grey	VT Verde laurel Laurel green	VG Verde caqui Khaki green	VP Verde pistacho Pistachio green	VA Aquamarina Sea blue
					
HD Amarillo mostaza Mustard yellow	BG Chocolate Chocolate	BT Tostado Mocha brown	BE Humo Smoke	BD Piedra Stone	BC Blanco crema Cream white
					
CV Rojo vivo Bright red	CG Granate Burgundy	RO Rojo Red	CD Naranja Orange	CC Vainilla Vanilla	CB Blanco roto Faded white
					
NE Negro Black	GF Gris profundo Deep grey	GA Gris antracita Anthracite grey	*GE Gris ratón Mouse grey	GC Gris claro Light grey	GD Blanco sucio Off white

Los acabados cuyo código está representado en rojo tienen un incremento respecto a la tarifa del 3%.
The finishes whose code is shown in red have an increase over the rate of 3%.

PINTURA METALIZADA · METALLIC EPOXY



GP Gris platino
Platinum grey



GG Gris grafito
Graphite grey

CERTIFICADOS CERTIFICATIONS

CERTIFICADOS DE LA EMPRESA COMPANY'S CERTIFICATIONS



ISO 14001

En 2007 implementamos el sistema internacional de gestión ambiental ISO 14001, y desde entonces trabajamos intensamente para reducir el impacto medioambiental de nuestros productos, buscando la mejora continua en cada proceso y en cada producto.

ISO 14001

In 2007, we implemented the International Environmental Management System ISO 14001 and are actively engaged in reducing the environmental impact of our products and the pursuit of continuous improvement.



Certificación PEFC

La certificación PEFC (Programa de Aprobación y Certificación Forestal) demuestra que Dynamobel puede garantizar el suministro de madera procedente de bosques gestionados para una explotación controlada y sostenible, evitando de esta forma la deforestación incontrolada y la tala ilegal.

PEFC certification

Dynamobel can guarantee the supply of wood from forests managed for controlled exploitation and sustainable, thus avoiding uncontrolled deforestation and logging illegal.



Certificación FSC

La obtención del certificado de cadena de custodia FSC garantiza que, en Dynamobel, cumplimos los estrictos requisitos necesarios para distribuir productos certificados que garanticen su origen en bosques gestionados para obtener madera sostenible, desde el punto de vista medioambiental, económico y social.

FSC certification

Obtaining the certificate of FSC chain of custody ensures that in Dynamobel, we adhere to strict requirements for distributing certified products to ensure originated in forests managed for sustainable timber.



Otras certificaciones internacionales

Nos comprometemos a obtener el certificado de producto que se requiera para cualquiera de nuestros productos en un país determinado. Por ejemplo, en 2008 obtuvimos el GECA para la silla DIS, que es una certificación medioambiental independiente para Australia, que garantiza un impacto medioambiental mínimo en el ciclo de vida del producto.

Another international certifications

We are committed to obtaining the certificate of product required for any of our products in a given country. For example, in 2008 obtained the chair GECA for DIS, which is a independent environmental certification for Australia, which ensures minimal environmental impact in the product life cycle.

SOBRE NOSOTROS

ABOUT US

•

POLÍTICA MEDIOAMBIENTAL

En Dynamobel apostamos por el futuro y por un desarrollo sostenible que lo garantice. Por ese motivo, un 70% de la energía que consumimos proviene de fuentes renovables.

••

ENVIRONMENTAL POLICIES

We have made a commitment to the future and to the sustainable development that ensures it. At Dynamobel, 70% of the energy that we consume comes from renewable sources.

70%

GESTIÓN DEL FIN DE LA VIDA ÚTIL

LIFE CYCLE STAGES



1

MATERIALES

Extracción y transformación de las materias primas y el suministro de componentes.

MATERIALS

Material extraction and transformation and component supply.

3

TRANSPORTE

Transporte de los proveedores hasta Dynamobel y de éste hasta nuestro cliente.

TRANSPORT

From the suppliers to Dynamobel, and from Dynamobel to our client.

2

PRODUCCIÓN

Todos los procesos productivos. Estos datos se obtienen de proveedores y de nuestro sistema de gestión medioambiental ISO 14001.

PRODUCTION

All production processes. This information is obtained from the suppliers and the ISO 14001 environmental management system at Dynamobel.

4

USO

Durante este proceso no se realizan intercambios ambientales.

USE

In this process, no environmental exchanges take place.

5

ELIMINACIÓN

El modo de eliminación de cada producto o su conversión en recurso.

ELIMINATION

The mode of elimination for each product or its conversion into a resource.

Dynamobel S.A.

CENTRAL INBOX, SPAIN

Ctra. Madrid Km 24
31350 Peralta
Navarra, Spain
T +34 948 750 000
F +34 948 750 750
info@dynamobel.com

CENTRAL BOX, SPAIN

Ctra. de Guipúzcoa Km 7,5
Apdo. 1074 31080 Pamplona
Navarra, Spain
T +34 948 303 171
F +34 948 302 581
info@dynamobel.com

Nos salimos de la estructura rígida de muchas empresas del sector en el que se imponen soluciones estándar sin cuestionarse las limitaciones que éstas imponen en las buenas ideas.

Nuestro propósito es ir más allá, un paso por delante, porque creemos que las buenas ideas merecen más que una solución masiva.

Trabajamos por entender a los creadores y explorar formas de resolver sus obras, que ofrezcan un adecuado equilibrio entre personalización e industrialización. Las buenas ideas no comprometen forma ni función. Defenderemos esto ante todo.

We are breaking out of the rigid structure through which many companies in the sector impose standard solutions without questioning the constraints these place on good ideas.

Our aim is to venture beyond, stay one step ahead, because we believe that good ideas deserve more than a simple, all-embracing solution.

We work to understand designers and look into ways of solving their work, providing a suitable balance between customisation and industrialisation. Good ideas do not compromise form or function. We will defend that come what may.

