

GRADE

The Grade programme is an evolution of traditional management furniture, a leap towards a more contemporary look, in line with the new trends in the workplace.

The programme is available in highly attractive materials, such as varnished wood and laminates, in order to offer a wide range of solutions and surface-finish qualities.

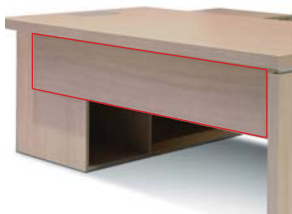

STANDARD FEATURES

- Wooden modesty panel.



OPTIONAL FEATURES

- Aluminium flip-up cover on the side with tray (on the independent desk).
- Stainless steel trim between the table top and leg.

GRADE

DESCRIPTION

STRUCTURE

Welded assembly consisting of 1.5-mm thick 50x30 cold-rolled steel profiling as per DIN 2395. Welded corners, forming a rectangle.

Leg panel

50-mm thick chipboard bonded with synthetic resins and especially designed for applications that require high bending strength. Average density: 660/635 kg/m³ as per EN 323.

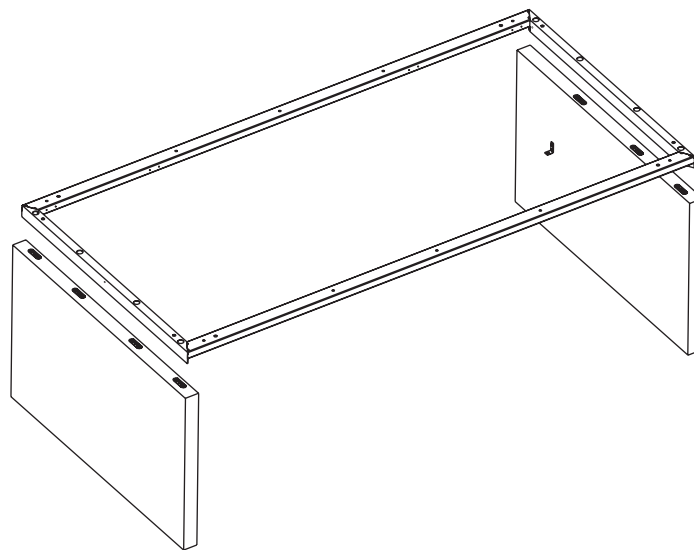

Structural modesty panel

Made of 370-mm high, 19-mm thick chipboard, set back 200 mm from the front. Fastened on the sides to the legs and desk top.

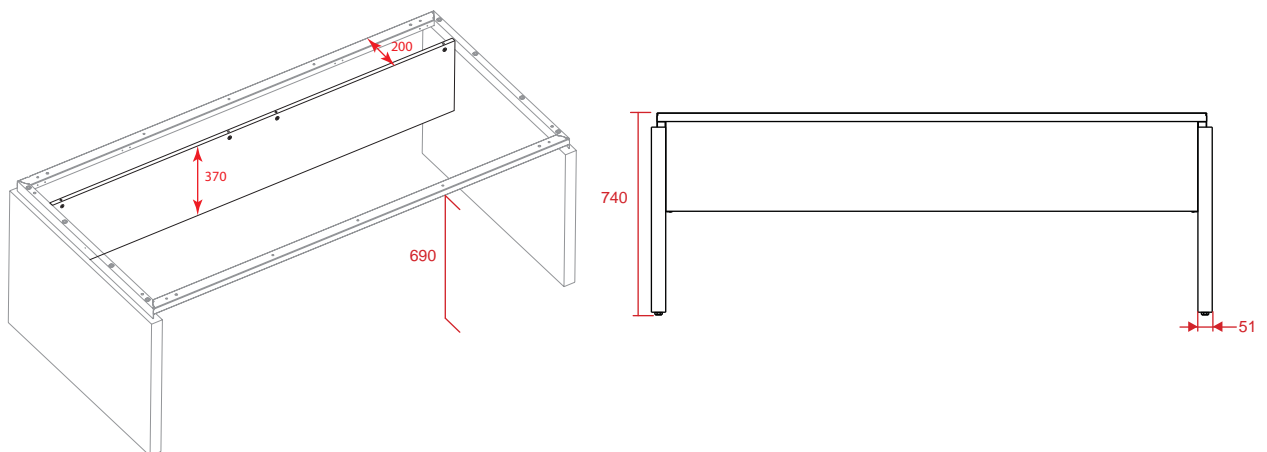

The metal parts are degreased, washed and phosphated before being coated with 60/80 µm epoxy powder and then polymerised. The powder coating complies with the current reaction to fire standard UNE 23827-90

The frame is joined to the desk top with M6 screws.

The legs and modesty panel are available in the same finishes as the desk top.

GRADE

TABLE TOP

19-mm thick chipboard bonded with synthetic resins and especially designed for applications that require high bending strength. Average density: 660/635 kg/m³ as per EN 323. With extra underside edging on the perimeter to make a thickness of 50 mm.

Laminated finish. 2-mm thick PVC edge as per UNE 56.843:01.

Or finished in wood treated with water-based varnish, with 2-mm thick wood edge.

The return can be fitted on either the right or left of the main desk.

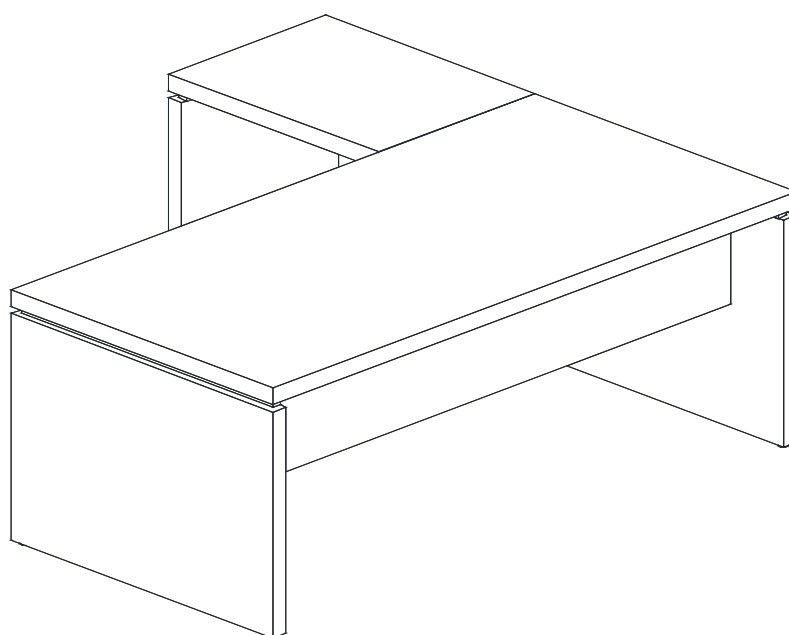

FLIP-UP COVER



GRADE

INDEPENDENT CREDENZA MODULE AND CREDENZA TO PROP DESK MODULE

The difference between them lies in the top surface. The top surface on the independent credenza is 50-mm thick and on the module to prop a desk it is 25-mm thick. In both cases the top surface is ordered separately.

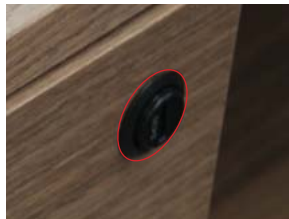
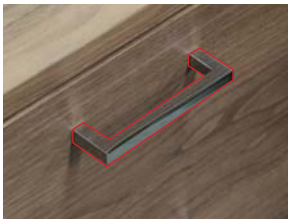

OPTIONAL FEATURES

- Chrome handle
- Lock
- Mastered lock
- Top surface with aluminium flip-up cover and tray for the sliding-door prop module.

GRADE

DESCRIPTION

STRUCTURE

The body/structure is made of 19-mm thick chipboard, except the base which is 25-mm thick (top surface not included).

Metal reinforcement on the front at the top for extra stability.

4 types of module:

- Lower hinged doors and upper drawer
- Hinged doors.
- Hinged doors and interior drawer.
- Sliding doors.

The sliding-door module used as a prop is always placed beneath the desk and comes with a cable grommet in the base to manage the cables to the propped desk. The tracks are built into the base and top surface.

The sliding doors have damping for soft closing.

MODULES FOR CREDENZA TO PROP DESK

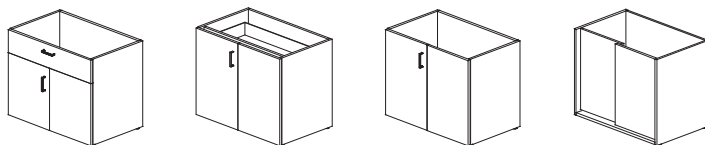

Top surfaces for credenza modules to prop desk

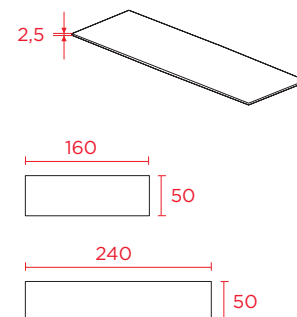

INDEPENDENT CREDENZA MODULES

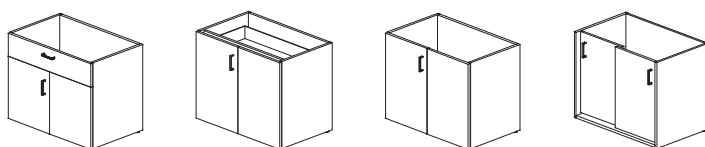

Top surfaces for independent credenza modules

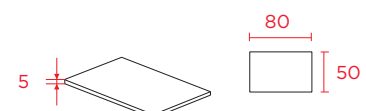

GRADE

DRAWER UNIT AND CREDENZA TO PROP DESK



FEATURES

- Anti-overturn lock system which prevents two drawers being opened at the same time.
- Ball-guide system which provides greater resistance and enhanced glide.
- 5th castor on the file drawer to prevent overturn.
- On castors or glides.

PRESTACIONES OPCIONALES

- Layout: 3 drawers or drawer + filing drawer.
- Chrome handle.
- Lock.
- Mastered lock.
- Push-open system.
- Drawer insert with small compartments.

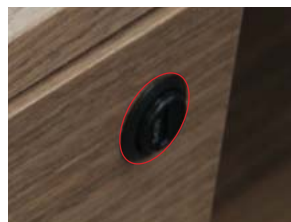
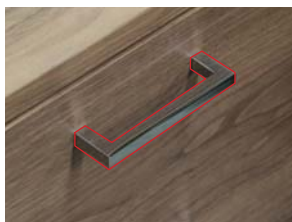

Credenza to prop desk

Left-hand credenza

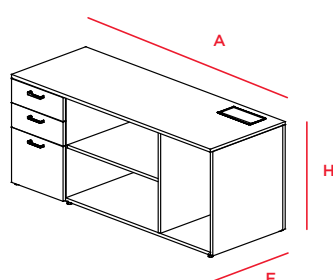

Right-hand credenza

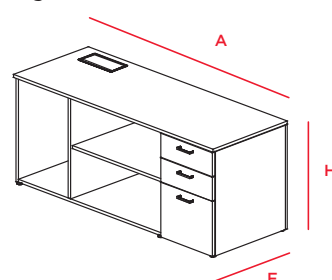

A 160

F 60

H 67

GRADE

DESCRIPTION

STRUCTURE

Rear, sides, fronts and top surface in 19-mm thick chipboard joined together with metal eccentric fasteners with a diameter of 15 mm.

Laminated or varnished wood finish.

Drawer body in 0.8-mm thick steel which permits opening to three quarters the drawer depth.

File drawer body in 0.8-mm thick steel which permits total opening via telescopic guides. Includes frame for folders.



GRADE DRAWER UNIT

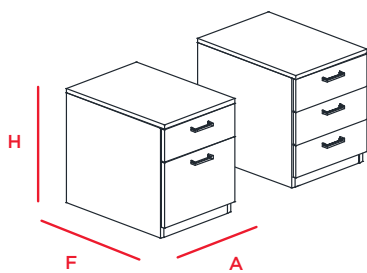

A 42
F 58.7
H 54.3



End in octagonal levellers which adjust 15 mm.

GRADE INDEPENDENT CREDENZA Y AND CREDENZA TO PROP DESK

RANGE

INDIVIDUAL TABLE

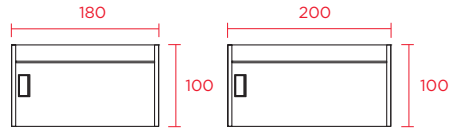

DESK PROPPED ON CREDENZA

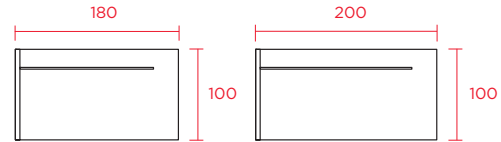

RETURN

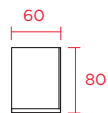

CREDENZA TO PROP DESK

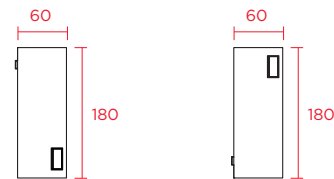

Left-hand credenza

Right-hand credenza

MODULE WITHOUT TOP SURFACE FOR CREDENZA TO PROP DESK

A 80 F 50 H 64,5

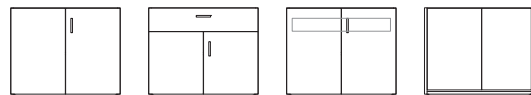

TOP SURFACE FOR CREDENZA MODULE TO PROP DESK, THICKNESS 25

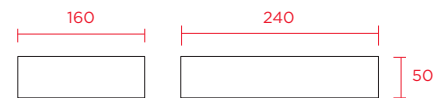

MODULE WITHOUT TOP SURFACE FOR INDEPENDENT CREDENZA

A 80 F 50 H 64,5



TOP SURFACE FOR INDEPENDENT CREDENZA, THICKNESS 50

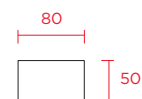

GRADE DRAWER UNITS



Mobile

With fixed glides

CERTIFICATIONS AND STANDARDS



EN 527